

IO-ATC8 I/O Expansion Module 8 Analog/Thermocouple Inputs

The IO-ATC8 is an I/O Expansion Module that can be used in conjunction with specific Unitronics OPLC controllers.

The module offers 8 inputs that may be set as either analog or thermocouple inputs via wiring, jumper and software settings.

The interface between the module and the OPLC is provided by an adapter.

The module may either be snap-mounted on a DIN rail, or screw-mounted onto a mounting plate.

Component identification

1	Module-to-module connector
2	Communication status indicator
3	Input connection points, I4 to I7
4	Input status indicators
5	Module-to-module connector port
6	Input connection points, I0 to I3

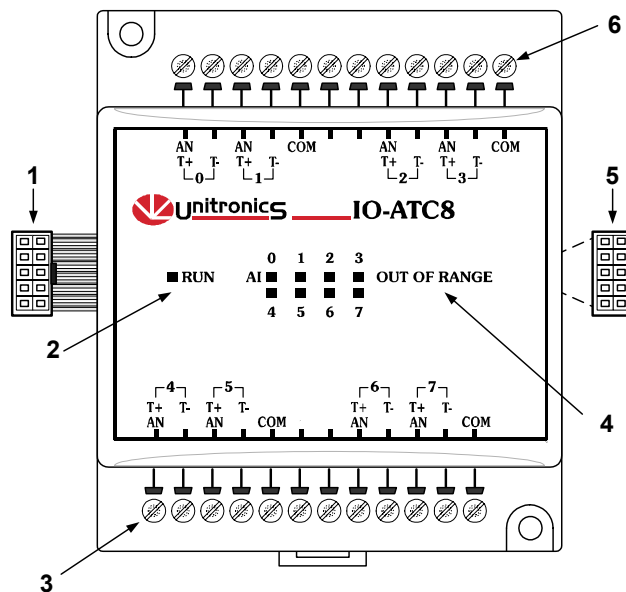

- Before using this product, it is the responsibility of the user to read and understand this document and any accompanying documentation.
- All examples and diagrams shown herein are intended to aid understanding, and do not guarantee operation. Unitronics accepts no responsibility for actual use of this product based on these examples.
- Please dispose of this product in accordance with local and national standards and regulations.
- Only qualified service personnel should open this device or carry out repairs.

User safety and equipment protection guidelines

This document is intended to aid trained and competent personnel in the installation of this equipment as defined by the European directives for machinery, low voltage, and EMC. Only a technician or engineer trained in the local and national electrical standards should perform tasks associated with the device's electrical wiring.

Symbols are used to highlight information relating to the user's personal safety and equipment protection throughout this document. When these symbols appear, the associated information must be read carefully and understood fully.

Symbol	Meaning	Description
	Danger	The identified danger causes physical and property damage.
	Warning	The identified danger can cause physical and property damage.
Caution	Caution	Use caution.



- Failure to comply with appropriate safety guidelines can result in severe personal injury or property damage. Always exercise proper caution when working with electrical equipment.



- Check the user program before running it.
- Do not attempt to use this device with parameters that exceed permissible levels.
- To avoid damaging the system, do not connect / disconnect the device when the power is on.

Environmental Considerations



- Do not install in areas with: excessive or conductive dust, corrosive or flammable gas, moisture or rain, excessive heat, regular impact shocks or excessive vibration.



- Leave a minimum of 10mm space for ventilation between the top and bottom edges of the device and the enclosure walls.
- Do not place in water or let water leak onto the unit.
- Do not allow debris to fall inside the unit during installation.

Mounting the Module

DIN-rail mounting

Snap the device onto the DIN rail as shown below; the module will be squarely situated on the DIN rail.

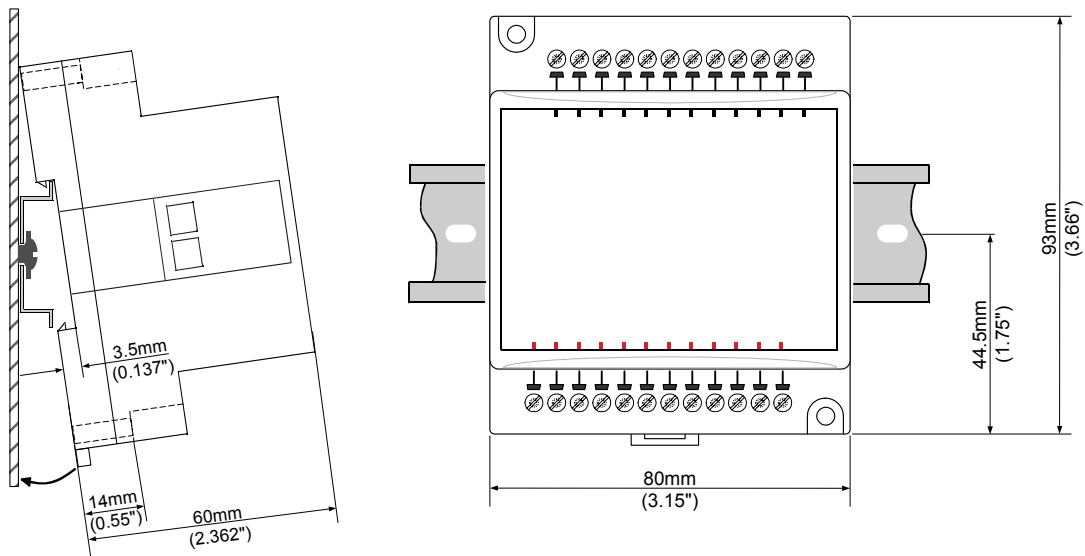

Screw-Mounting

The figure below is not drawn to scale. It may be used as a guide for screw-mounting the module.

Mounting screw type: either M3 or NC6-32.

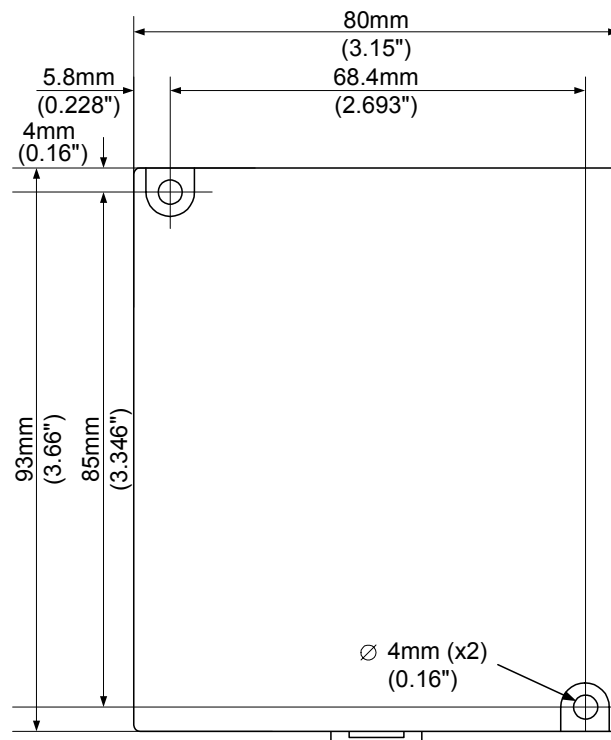

Connecting Expansion Modules

An adapter provides the interface between the OPLC and an expansion module. To connect the I/O module to the adapter or to another module:

1. Push the module-to-module connector into the port located on the right side of the device.

Note that there is a protective cap provided with the adapter. This cap covers the port of the **final** I/O module in the system.



- To avoid damaging the system, do not connect or disconnect the device when the power is on.

Component identification

1	Module-to-module connector
2	Protective cap

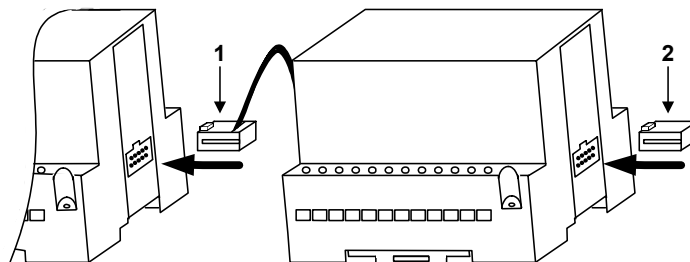

Wiring



- Do not touch live wires.



- Unused pins should not be connected. Ignoring this directive may damage the device.
- Do not connect the 'Neutral' or 'Line' signal of the 110/220VAC to the device's COM pins.
- Double-check all wiring before turning on the power supply.

Wiring Procedures

Use crimp terminals for wiring; use 26-12 AWG wire (0.13 mm^2 – 3.31 mm^2) for all wiring purposes.

1. Strip the wire to a length of $7 \pm 0.5 \text{ mm}$ (0.250–0.300 inches).
2. Unscrew the terminal to its widest position before inserting a wire.
3. Insert the wire completely into the terminal to ensure that a proper connection can be made.
4. Tighten enough to keep the wire from pulling free.

- To avoid damaging the wire, do not exceed a maximum torque of 0.5 N·m (5 kgf·m).
- Do not use tin, solder, or any other substance on stripped wire that might cause the wire strand to break.
- Install at maximum distance from high-voltage cables and power equipment.

I/O Wiring—General

- Input or output cables should not be run through the same multi-core cable or share the same wire.
- Allow for voltage drop and noise interference with input lines used over an extended distance. Use wire that is properly sized for the load.

Analog Inputs

- Shields should be connected at the signal source.
- Inputs may be set as either thermocouple, current, or voltage. To set an input:
 - Use the appropriate wiring as shown below.
 - Open the device and set the jumpers according to the instructions beginning on page 6.
- The adapter and the COM signals of the analog inputs must be connected to the same 0V signal.
- The COM signals of each channel are internally shorted.
- When set to current/voltage, each 2 inputs share a common COM signal.

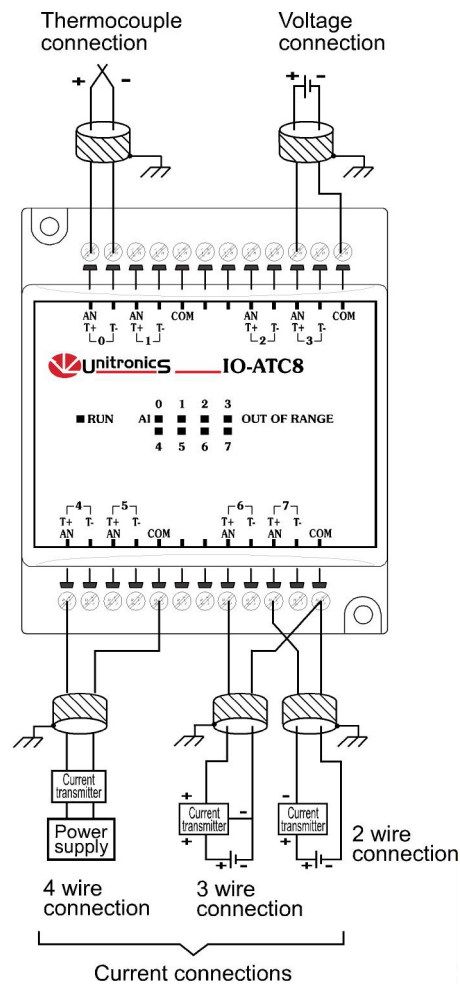

Opening the Device

- Before opening the device, touch a grounded object to discharge any electrostatic charge.
- Avoid touching the PCB board directly.
- Turn power off and disconnect all leads before opening the device.

In order to change the jumper settings of a specific input, first open the device by prying off its back, using the blade of a flat-bladed screwdriver. The insertion points for the screwdriver are located on both sides of the module.

1. Open the first side of the device by inserting the blade between the 2 plastic moldings as shown below, then gently pushing up.



2. Taking care not to damage the cable, open the other side of the device by inserting the blade where shown below, then gently pushing up.



- 3. Gently remove the top of the device as shown.

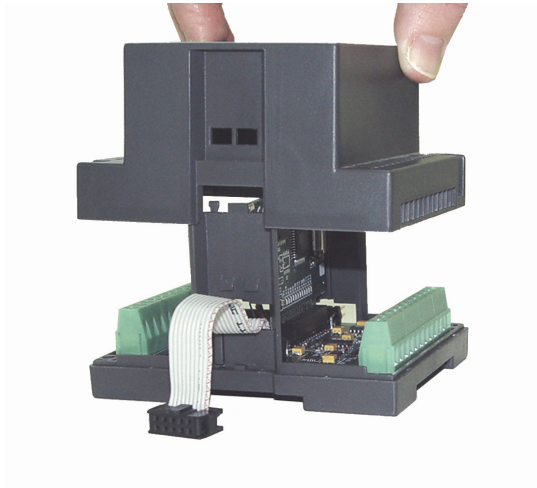

- 4. The jumpers are shown at right. Change the jumper settings as required, in accordance with the tables shown on the next page.

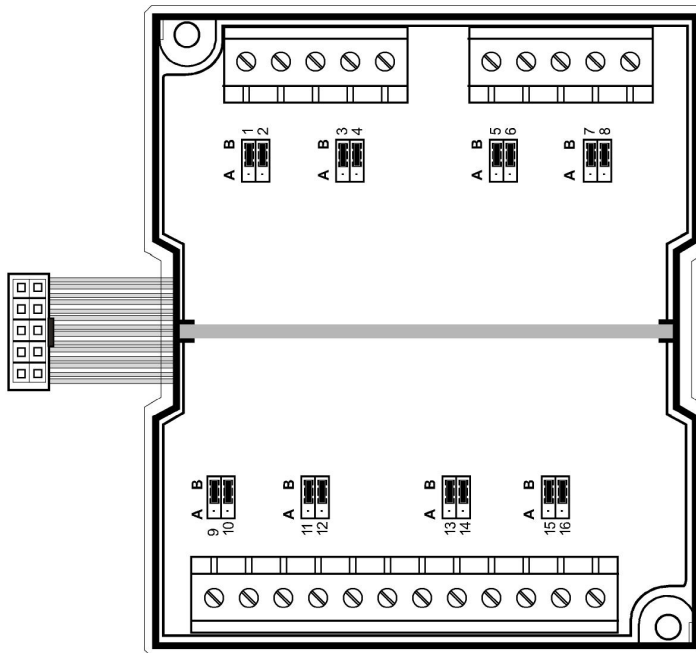

Jumper Settings

The tables below show how to set a specific jumper to change the functionality of a specific input. To open the device and access the jumpers, refer to the instructions beginning on page 6.

Caution ■ Incompatible jumper settings and wiring may severely damage the device.

	Jumper #	Thermocouple*	Voltage	Current
Input 0	1	B	A	A
	2	B	A	B
Input 1	3	B	A	A
	4	B	A	B
Input 2	5	B	A	A
	6	B	A	B
Input 3	7	B	A	A
	8	B	A	B
Input 4	9	B	A	A
	10	B	A	B
Input 5	11	B	A	A
	12	B	A	B
Input 6	13	B	A	A
	14	B	A	B
Input 7	15	B	A	A
	16	B	A	B

* Default factory setting.

IO-ATC8 Technical Specifications

Max. current consumption	40mA maximum from the adapter's 5VDC
Typical power consumption	0.2W@5VDC
Status indicator (RUN)	Green LED: —Lit when a communication link is established between module and OPLC. —Blinks when the communication link fails.

Thermocouple Inputs

Number of inputs	8. See Note 1.
Input type	Thermocouple, differential inputs. See Note 2.
Input range	As shown in table below.
Isolation	None
Conversion method	Voltage to frequency
Resolution	0.1°C (0.1°F) See Note 3.
Conversion time	100mSec minimum, according to the filter type selected in software settings
Input impedance	>10MΩ
Cold junction compensation	Local, automatic
Cold junction compensation error	±1.5°C (±2.7°F) maximum
Absolute maximum rating	±0.6VDC
Linearity error	0.04% maximum of full scale
Error limit	0.4% of input value
Warm-up time	Typically ½ hour, ±1°C (±1.8°F) repeatability
Status indicators (OUT OF RANGE)	Red LEDs—Lit when the corresponding input measures an analog value in excess of the input range. See Note 4.

Thermocouple input ranges

Type	Temperature range	Wire color	
		ANSI (USA)	BS 1843 (UK)
mV	-5 to 56mV	-	-
B	200 to 1820°C (300 to 3276°F)	+ Grey - Red	+ None - Blue
E	-200 to 750°C (-328 to 1382°F)	+ Violet - Red	+ Brown - Blue
J	-200 to 760°C (-328 to 1400°F)	+ White - Red	+ Yellow - Blue
K	-200 to 1250°C (-328 to 2282°F)	+ Yellow - Red	+ Brown - Blue
N	-200 to 1300°C (-328 to 2372°F)	+ Orange - Red	+ Orange - Blue
R	0 to 1768°C (32 to 3214°F)	+ Black - Red	+ White - Blue
S	0 to 1768°C (32 to 3214°F)	+ Black - Red	+ White - Blue
T	-200 to 400°C (-328 to 752°F)	+ Blue - Red	+ White - Blue

Analog Inputs

Number of inputs	8 (single-ended) See Note 1.
Input range	0-10V, 0-20mA, 4-20mA. See Note 1.
Input type	Either Normal or Fast mode, according to the filter type selected in software settings
Conversion method	Voltage to frequency
Normal mode	
Resolution at 0-10V, 0-20mA	14-bit (16384 units)
Resolution at 4-20mA	3277 to 16383 (13107 units)
Conversion time	100mSec minimum per input
Fast mode	
Resolution at 0-10V, 0-20mA	12-bit (4096 units)
Resolution at 4-20mA	819 to 4095 (3277 units)
Conversion time	25mSec minimum per input
Input impedance	>400K Ω —voltage 500 Ω —current
Isolation	None
Absolute maximum rating	$\pm 15V$ —voltage $\pm 30mA$ —current
Linearity error	0.04% max of full scale
Error limits	0.4% of input value
Status indicators	
(OUT OF RANGE)	Red LEDs—Lit when the corresponding input is receiving current or voltage in excess of the input range. See Note 5.

Environmental	IP20/NEMA1
Operating temperature	0° to 50°C (32 to 122° F)
Storage temperature	-20° to 60°C (-4 to 140° F)
Relative Humidity (RH)	5% to 95% (non-condensing)
Dimensions (WxHxD)	80mm x 93mm x 60mm (3.15 x 3.66 x 2.362")
Weight	150g (5.3 oz)
Mounting	Either onto a 35mm DIN-rail or screw-mounted.

Notes:

- Each input may be set as either thermocouple, voltage (0-10V), or current (0-20mA, 4-20mA) via wiring, jumper and software settings.
- The device can also measure voltage within the range of -5 to 56mV, at a resolution of 0.01mV. The device can also measure raw value frequency at a resolution of 14-bits(16384).
- The input analog value represents the measured value as shown in the following examples:
 - Thermocouple: a value of 262 is represented as 26.2°C.
 - mV: value of 262 is represented as 2.62mV.
- The value of a thermocouple may also indicate when the sensor is not connected to the input, or when the analog value exceeds the permissible range. If such is the case, the value will be 32767.
- The voltage or current value of analog inputs can also indicate faults, as shown in the table below.

Value: 12-bit (Fast mode)	Value: 14-bit (Normal mode)	Input Value Deviates:
-1	-1	Slightly below the input range.
4096	16384	Slightly above the input range.
32767	32767	Greatly above or below the input range.

Addressing I/Os on Expansion Modules

Inputs and outputs located on I/O expansion modules that are connected to an OPLC are assigned addresses that comprise a letter and a number. The letter indicates whether the I/O is an input (I) or an output (O). The number indicates the I/O's location in the system. This number relates to both the position of the expansion module in the system, and to the position of the I/O on that module.

Expansion modules are numbered from 0-7 as shown in the figure below.

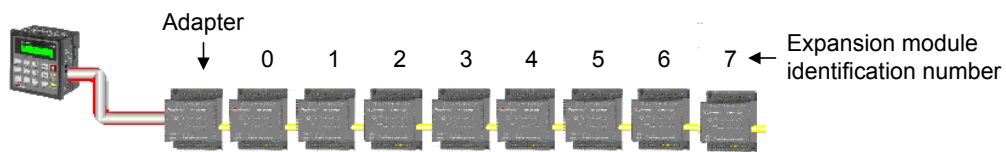

The formula below is used to assign addresses for I/O modules used in conjunction with the OPLC.

X is the number representing a specific module's location (0-7). Y is the number of the input or output on that specific module (0-15).

The number that represents the I/O's location is equal to:

$$32 + x \cdot 16 + y$$

Examples

- Input #3, located on expansion module #2 in the system, will be addressed as I 67,
 $67 = 32 + 2 \cdot 16 + 3$
- Output #4, located on expansion module #3 in the system, will be addressed as O 84,
 $84 = 32 + 3 \cdot 16 + 4$.

EX90-DI8-RO8 is a stand-alone I/O module. Even if it is the only module in the configuration, the EX90-DI8-RO8 is always assigned the number 7.

Its I/Os are addressed accordingly.

Example

- Input #5, located on an EX90-DI8-RO8 connected to an OPLC will be addressed as I 149, $149 = 32 + 7 \cdot 16 + 5$

About Unitronics

Unitronics Industrial Automation Systems has been producing PLCs, automation software and accessory devices since 1989.

Unitronics' OPLC controllers combine full-function PLCs and HMI operating panels into single, compact units. These HMI + PLC devices are programmed in a single, user-friendly environment. Our clients save I/O points, wiring, space, and programming time; elements that translate directly into cost-efficiency.

Unitronics supports a global network of distributors and sales representatives, as well as a U.S. subsidiary.

For more information regarding Unitronics products, contact your distributor, Unitronics headquarters via email: export@unitronics.com, or visit the Unitronics website at <http://www.unitronics.com/>.



Under no circumstances will Unitronics be liable or responsible for any consequential damage that may arise as a result of installation or use of this equipment, and is not responsible for problems resulting from improper or irresponsible use of this device.

No part of this document may be used for any purpose other than for the purposes specifically indicated herein nor may it be reproduced or transmitted in any form or by any means, electronic or mechanical, including photocopying and/or recording, for any purpose without written permission from Unitronics.

The information appearing in this document is for general purposes only. Unitronics makes no warranty of any kind with regard to the information appearing in this document, including, but not limited to, implied warranties of merchantability and/or fitness for a particular use or purpose. Unitronics assumes no responsibility for the results, direct and/or indirect, of any misuse of the information appearing in this document nor for any use of the Unitronics products referred to herein in any manner deviating from the recommendations made in this document. Unitronics assumes no responsibility for the use of any parts, components, or other ancillary appliances including circuitry other than as recommended hereunder or other than that embodied in the Unitronics product.

Unitronics retains all rights to its proprietary assets including, but not limited to its software products which are copyrighted and shall remain the property of Unitronics. Copyright protection claimed includes all Forms and matters of copyrightable materials and information legally allowed including but not limited to material generated from the software programs which are displayed on the screen of the Unitronics products such as styles, templates, icons, screen displays, looks, etc. Duplication and/or any unauthorized use thereof are strictly prohibited without prior written permission from Unitronics.

All brand or product names are used for identification purpose only and may be trademarks or registered trademarks of their respective holders.

Unitronics reserves the right to revise this publication from time to time and to amend its contents and related hardware and software at any time. Technical updates (if any) may be included in subsequent editions (if any).

Unitronics product sold hereunder can be used with certain products of other manufacturers at the user's sole responsibility.