

## DataMan<sup>®</sup> 280 Series Quick Reference Guide



2023 November 16  
Revision: 23.3.1.3

# Precautions

To reduce the risk of injury or equipment damage, observe the following precautions when you install the Cognex product:

- Connectivity is possible through the following options:
  - 24 VDC (+/- 10%) output connection using a UL or NTRL listed power supply
  - Power over Ethernet (PoE) 13 W power supply

Any other voltage creates a risk of fire or shock and can damage the components. Applicable national and local wiring standards and rules must be followed.

- This product is intended for industrial use in automated manufacturing or similar applications.
- The safety of any system incorporating this product is the responsibility of the assembler of the system.
- Do not install Cognex products where they are exposed to environmental hazards such as excessive heat, dust, moisture, humidity, impact, vibration, corrosive substances, flammable substances, or static electricity.
- Route cables and wires away from high-current wiring or high-voltage power sources to reduce the risk of damage or malfunction from the following causes: over-voltage, line noise, electrostatic discharge (ESD), power surges, or other irregularities in the power supply.
- Do not expose the image sensor to laser light. Image sensors can be damaged by direct, or reflected, laser light. If your application requires laser light that might strike the image sensor, use a lens filter at the corresponding laser wavelength. For suggestions, contact your local integrator or application engineer.

- This product does not contain user-serviceable parts. Do not make electrical or mechanical modifications to product components. Unauthorized modifications can void your warranty.
- Changes or modifications not expressly approved by the party responsible for regulatory compliance could void the user's authority to operate the equipment.
- Include service loops with cable connections.
- Ensure that the cable bend radius begins at least six inches from the connector. Cable shielding can be degraded or cables can be damaged or wear out faster if a service loop or bend radius is tighter than 10X the cable diameter.
- This device should be used in accordance with the instructions in this manual.
- All specifications are for reference purposes only and can change without notice.

# Symbols

The following symbols indicate safety precautions and supplemental information:



**WARNING:** This symbol indicates a hazard that could cause death, serious personal injury or electrical shock.

---



**CAUTION:** This symbol indicates a hazard that could result in property damage.

---



**Note:** This symbol indicates additional information about a subject.

---



**Tip:** This symbol indicates suggestions and shortcuts that might not otherwise be apparent.



---











# DataMan 280 Series Accessories

You can purchase the following components separately. For a list of options and accessories, contact your local Cognex sales representative.



## Lenses

Accessory	Product Number	Illustration	DM280	DM282
6.2 mm lens kit that includes: <ul style="list-style-type: none"><li>• 6.2 mm optics mount</li><li>• 6.2 mm lens</li><li>• Manual lens cap (assembled)</li><li>• Screws</li></ul>	DM280-LENS-62		✓	
UV Light Kit for 6.2 mm lens <ul style="list-style-type: none"><li>• UV light board (365 nm wavelength)</li><li>• UV resistant front cover</li><li>• screws</li></ul>	DM280-UV365-62		✓	
16 mm lens kit with extended optics mount (requires the use of an extended front cover and high-powered red LED). The kit includes: <ul style="list-style-type: none"><li>• 16 mm optics mount</li><li>• 16 mm lens</li><li>• Manual lens cap (assembled)</li><li>• Screws</li></ul>	DM260-LENS-16		✓	



Accessory	Product Number	Illustration	DM280	DM282
IR 6.2 mm lens kit, 3-position with IR LED includes: <ul style="list-style-type: none"> <li>• 6.2 mm optics mount</li> <li>• 6.2 mm lens (IR)</li> <li>• Standard Infrared Light for 6.2mm (Risk Group Exempt acc. IEC62471)</li> <li>• Manual lens cap (not assembled)</li> <li>• Screws</li> </ul>	DM280-KIT-IR-62		✓	
IR 16 mm lens kit that includes: <ul style="list-style-type: none"> <li>• 16 mm optics mount</li> <li>• 16 mm lens (IR)</li> <li>• Standard Infrared Light for 16mm (Risk Group Exempt acc. IEC62471)</li> <li>• Manual lens cap (assembled)</li> <li>• Screws</li> </ul>	DMA-KIT-IR-16		✓	
High Speed Liquid Lens Module (HSSL) to be used with 6.2 mm lens or 16 mm lens	DMA-HSSL-280		✓	✓



Accessory	Product Number	Illustration	DM280	DM282
16 mm lens with ImageMax kit that includes: <ul style="list-style-type: none"> <li>• 16 mm optics mount</li> <li>• 16 mm lens</li> <li>• High Speed Liquid Lens Module (DMA-HSLL-280)</li> <li>• High Powered red LED illumination (DM260-LED-RED-HP) (Risk Group Exempt acc. IEC62471)</li> <li>• 2-LED half-polarized extended cover (DM260-LENS-16CVR-P) (Risk Group Exempt acc. IEC62471)</li> </ul>	DM280-KIT-IMGMAX		✓	
Blue bandpass filter	DM150-BP470		✓	
Blue bandpass filter, 450 nm	280-TORCH-BP450			✓
Red bandpass filter	DM150-BP635		✓	
Red bandpass filter, 635 nm	280-TORCH-BP635			✓

## Illumination

Accessory	Product Number	Illustration	DM280	DM282
Red LED Light for 6.2 mm Lens (Risk Group Exempt acc. IEC 62471)	DM150-LED-RED		✓	
White LED Light for 6.2 mm Lens (Risk Group Exempt acc. IEC 62471)	DM150-LED-WHT		✓	
Blue LED Light for 6.2 mm Lens (Risk Group Exempt acc. IEC 62471)	DM150-LED-BLU		✓	
High-Powered Red LED Light for 16 mm Lens (Risk Group Exempt acc. IEC 62471) For maximum light power 24 V DC supply is recommended.	DM280-LED-RED-HP		✓	
High-Powered White LED Light for 16 mm Lens (Risk Group Exempt acc. IEC 62471) For maximum light power 24 V DC supply is recommended.	DM280-LED-WHT-HP			✓

# Lens Covers

Accessory	Product Number	Illustration	DM280	DM282
Standard front cover. Use with a 6.2 mm lens only.	DM280-CVR-62		✓	
Standard front cover, half-polarized. Use with a 6.2 mm lens only.	DM280-LENS-62CVR-P		✓	
Standard front cover, fully-polarized. Use with a 6.2 mm lens only.	DM280-LENS-62CVR-F		✓	
Extended front cover. Use with a 16 mm lens only.	DM260-LENS-16CVR		✓	
Extended front cover, half-polarized. Use with a 16 mm lens only.	DM260-LENS-16CVR-P		✓	
Extended front cover, fully-polarized. Use with a 16 mm lens only.	DM260-LENS-16CVR-F		✓	
C-mount adapter, IP40	DM280-CMNT-00		✓	
C-mount cover, IP65	DM280-CMNT-CVR		✓	







Accessory	Product Number	Illustration	DM280	DM282
Cross-polarized cover for High-Power Integrated Torch	280-HPIT-COVPOL			✓
Clear cover for High-Power Integrated Torch	280-HPIT-COVCLR			✓
Diffuse cover for High-Power Integrated Torch	280-HPIT-COVDIF			✓
Dome Diffuser cover for High-Power Integrated Torch	280-TORCH-DOME			✓







**CAUTION:** For 280-HPIT-COVPOL, 280-HPIT-COVCLR, and 280-HPIT-COVDIF equipped with a laser aimer, the device has been tested to be under the limits of a Class 1 Laser device.



## Cables





**i Note:** Cables are sold separately.

Accessory	Product Number	Illustration	DM280	DM282
Ethernet Cable, X-coded M12-8 to RJ-45	CCB-84901-2001-xx (straight, xx specifies length: 2m, 5m, 10m, 15m, 30m)		✓	✓
Ethernet Cable, X-coded M12-8 to RJ-45	CCB-84901-2002-xx (right-angled, xx specifies length: 2m, 5m, 10m)		✓	✓
Ethernet Cable, Robotic X-Coded M12-8 to RJ-45	CCB-84901-2RBT-xx (straight, xx specifies length: 2m, 5m, 10m)		✓	✓
X-Coded to A-Coded Ethernet cable adapter, 0.5 m	CCB-M12X8MS-XCAC		✓	✓
Power and I/O Breakout Cable, M12-12 to Flying Lead	CCB-M12x12Fy-05 (y = straight/angled, xx specifies length)		✓	✓
Power and I/O Breakout Cable, M12-12 to Flying Lead	CCBL-05-01		✓	✓
Power and I/O Breakout Cable, M12-12 to Flying Lead	CCB-PWRIO- xx (straight, xx specifies length: 5m, 10m, 15m)		✓	✓

Accessory	Product Number	Illustration	DM280	DM282
Power and I/O Breakout Cable, M12-12 to Flying Lead	CCB-PWRIO-xxR (right-angled, xx specifies length: 5m, 10m, 15m)		✓	✓
I/O Module Cable M12-12 to DB15	CCB-PWRIO-MOD-xx (xx specifies length: 2m, 5m)		✓	✓
RS-232 Connection Cable	CCB-M12xDB9Y-05		✓	✓
I/O Extension Cable	CKR-200-CBL-EXT		✓	✓
Sealed USB Type C Cable to USB Type A, Straight, 2.5 m	DMA-STCBLE-IP65-25		✓	✓
Sealed USB Type C Cable to USB Type A, Straight 3.6 m	DMA-STCBLE-IP65-36		✓	✓
Sealed USB Type C Cable to USB Type A, Angled, 2.5 m	DMA-RTCBLE-IP65-25		✓	✓
Sealed USB Type C Cable to USB Type A, Angled, 3.6 m	DMA-RTCBLE-IP65-36		✓	✓



## Mounting Brackets

Accessory	Product Number	Illustration	DM280	DM282
Universal mounting bracket	DM100-UBRK-000	 A silver metal L-shaped bracket with a circular hole and a mounting hole.	✓	✓
Pivot mounting bracket	DM100-PIVOTM-01	 A blue metal bracket with a circular hole and a mounting hole.	✓	✓
Tilted angle pivot bracket	DMBK-DMPIVOT-00	 A blue metal bracket with a circular hole and a mounting hole, tilted at an angle.	✓	✓
Logistics mounting bracket and plate kit	DMA-BKT-LGS	 A kit including a blue metal bracket, a silver metal plate, and several screws.	✓	✓
Adjustable mirror bracket	DMA-262-MIR	 A black metal bracket with a yellow label and a cable attached.	✓	

# DataMan 280 Series Systems

## DataMan 280 Systems

	Omni-directional 1D Code	1D Max with Hotbars	High Speed Decoding	2DMax - Hard to read 2D codes	PowerGrid - Damaged 2D codes	Multi-Reader Sync	Resolution
DM-280L 1D Codes		✓	✓			✓	1440 x 1080
DM-280QL 1D Codes	✓	✓	✓			✓	
DM-280S 1D/2D Codes	✓	✓				✓	
DM-280Q 1D/2D Codes	✓	✓	✓	✓		✓	
DM-280X 1D/2D Codes	✓	✓	✓	✓	✓	✓	

# DataMan 282 Systems

	Omni-directional 1D Code	1D Max with Hotbars	High Speed Decoding	2DMax - Hard to read 2D codes	PowerGrid - Damaged 2D codes	Multi-Reader Sync	Resolution
DM-282L 1D Codes		✓	✓			✓	1920 x 1080
DM-282QL 1D Codes	✓	✓	✓			✓	
DM-282S 1D/2D Codes	✓	✓				✓	
DM-282Q 1D/2D Codes	✓	✓	✓	✓		✓	
DM-282X 1D/2D Codes	✓	✓	✓	✓	✓	✓	

# Setting Up Your DataMan Reader

Read this section to learn how the reader connects to its standard components and accessories.

**Note:**



- Cables are sold separately.
- If a standard component is missing or damaged, immediately contact your Cognex Authorized Service Provider (ASP) or Cognex Technical Support.



**CAUTION:** All cable connectors are keyed to fit the connectors on the reader. Do not force the connections or damage may occur.

## Reader Layout

The images and tables below show the elements of the reader.

DataMan 280:

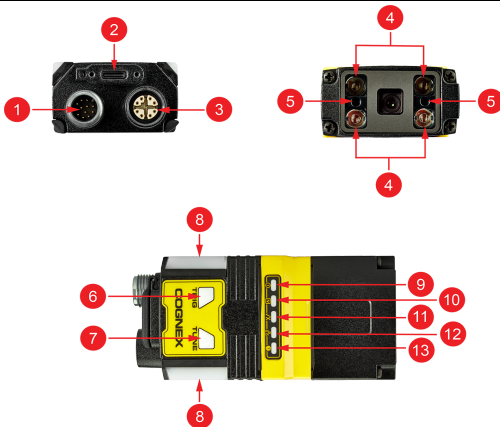

Number	Description
1	Power I/O Breakout cable connector
2	USB-C slot (with plastic cover)
3	Ethernet connector
4	Illumination LEDs
5	LED aimers
6	Trigger button
7	Tune button

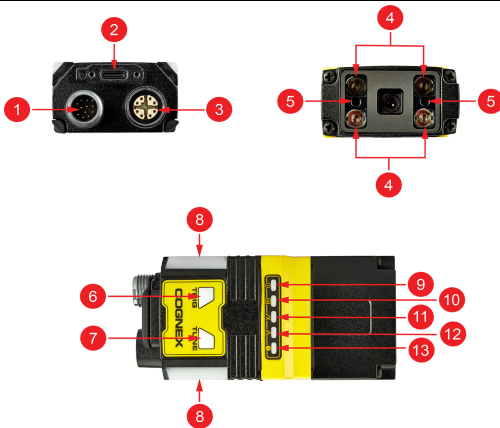

Number	Description
8	Indicator LEDs
9	Power LED indicator
10	Train status/Trigger status LED indicator
11	Good/bad read LED indicator
12	Communication LED indicator
13	Error LED indicator

DataMan 282:

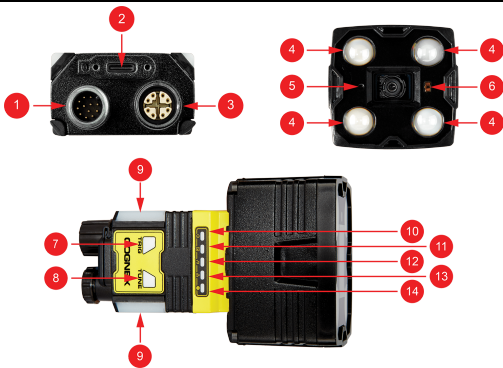

Number	Description
1	Power I/O Breakout cable connector
2	USB-C slot (with plastic cover)
3	Ethernet connector
4	Illumination LEDs
5	LED Aimer
6	Distance Sensor
7	Trigger button
8	Tune button



Number	Description
9	Indicator LEDs
10	Power LED indicator
11	Train status/Trigger status LED indicator
12	Good/bad inspection LED indicator
13	Communication LED indicator
14	Error LED indicator



# Dimensions

The following sections list dimensions of the reader.

**Note:**



- Dimensions are in millimeters and are for reference purposes only.
- All specifications are for reference purposes only and can change without notice.

## DataMan 280 with 6.2 mm lens

The following image shows the dimensions of DataMan 280, equipped with 6.2 mm lens.

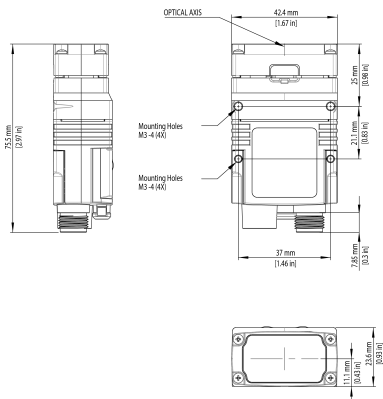

## DataMan 280 with 16 mm Lens

The following image shows the dimensions of DataMan 280 equipped with 16 mm lens.

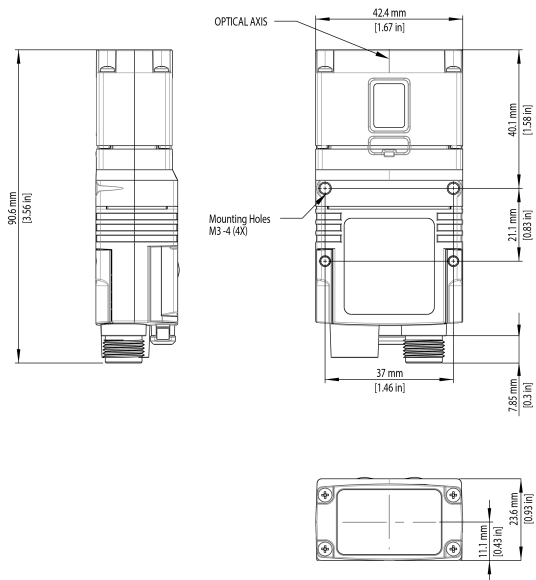

## DataMan 280 with L-shaped extension, equipped with 6.2 mm Lens

The following image shows the dimensions of DataMan 280 equipped with L-shaped extension and 6.2 mm lens.

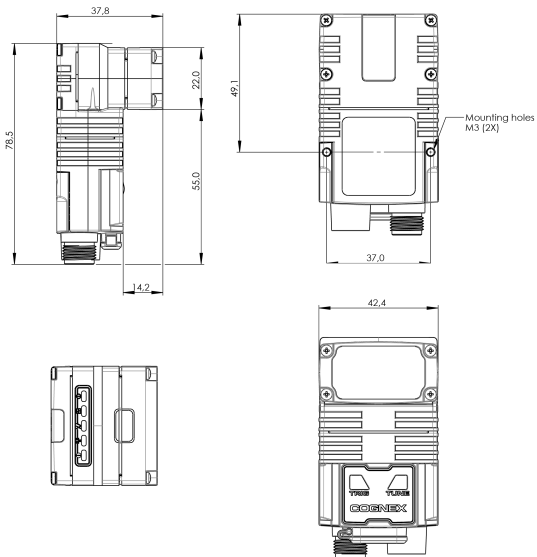

## DataMan 280 with L-shaped extension, equipped with 16 mm Lens

The following image shows the dimensions of DataMan 280 equipped with L-shaped extension and 16 mm lens.

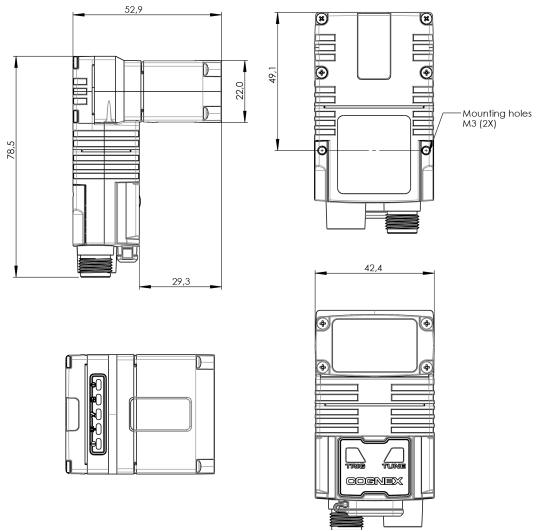

## DataMan 282 with High Power Integrated Torch

The following image shows the dimensions of DataMan 282 equipped with high power integrated torch.

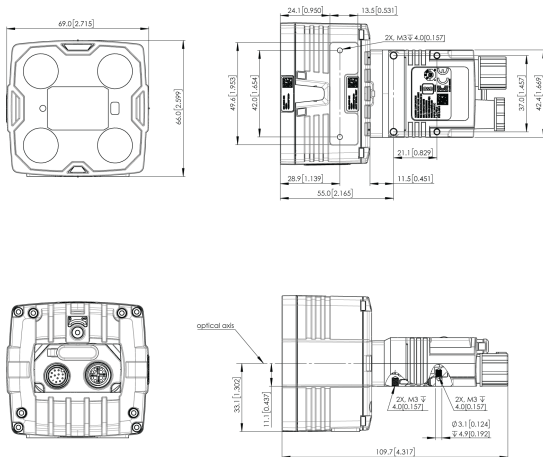

## DataMan 282 with High Power Integrated Torch - L-Shaped Extension

The following image shows the dimensions of DataMan 282 equipped with high power integrated torch and L-shaped extension.

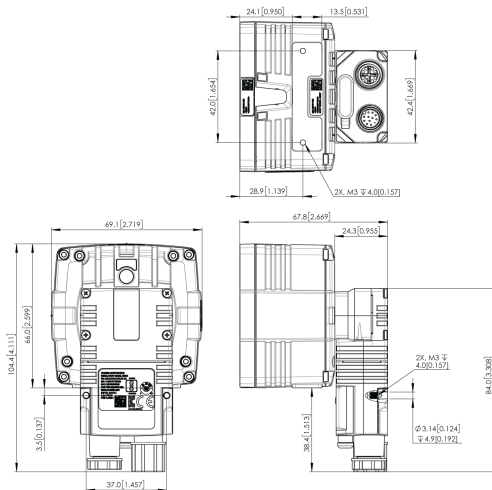



## Dataman 282 with Dome Front Cover - Right Angle Configuration

The following image shows the dimensions of DataMan 282 equipped with L-shaped extension and dome front cover.

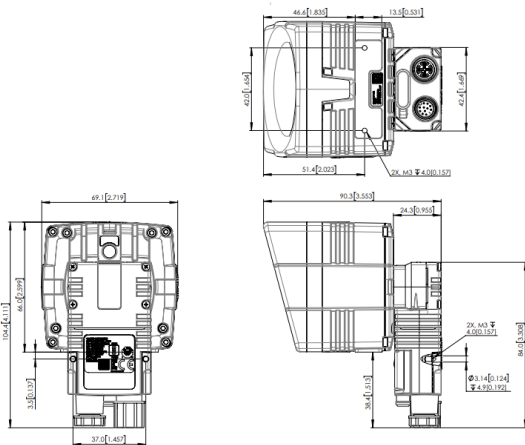



## Field of View and Reading Distance

This section provides the Field of View (FoV) values for 6.2 mm and 16 mm lenses.

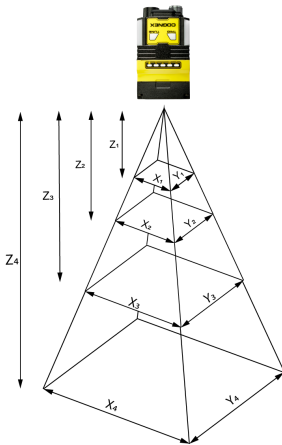

### DataMan 280 Readers with 6.2 mm Lens

6.2 mm lenses can be focused to 105 mm (short range) and to 190 mm (long range).

#### Short Range (Focused to 105 mm)

The following tables show the Field of View (FoV) widths of the 6.2 mm lens focused to 105 mm at various distances.

Working distance in mm	Horizontal values in mm	Vertical values in mm
$Z_1 = 40$	$X_1 = 38$	$Y_1 = 29$
$Z_2 = 65$	$X_2 = 58$	$Y_2 = 44$
$Z_3 = 105$	$X_3 = 90$	$Y_3 = 68$

Distances in mm	2D min. code in mil	1D min. code in mil
40	4	2
65	5	3
105	10	5

## Long Range (Focused to 190 mm)

The following table shows the Field of View (FoV) widths of the 6.2 mm lens focused to 190 mm at various distances.

Working distance in mm	Horizontal values in mm	Vertical values in mm
$Z_1 = 190$	$X_1 = 159$	$Y_1 = 119$
$Z_2 = 225$	$X_2 = 187$	$Y_2 = 140$
$Z_3 = 375$	$X_3 = 307$	$Y_3 = 230$
$Z_4 = 1000$	$X_4 = 808$	$Y_4 = 606$

<b>Distances in mm</b>	<b>2D min. code in mil</b>	<b>1D min. code in mil</b>
150	10	6
190	12	8
225	15	8
375	20	15
500	30	20
1000	60	35

## DataMan 280 Readers with 16 mm lens

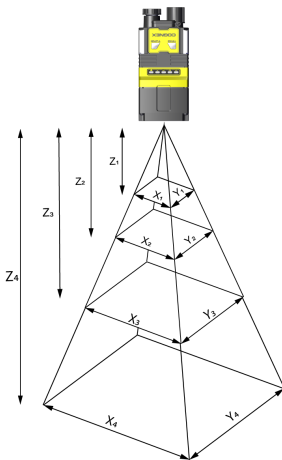

The following tables list the Field of View (FoV) widths of the 16 mm lens at various distances:

Working distance in mm	Horizontal values in mm	Vertical values in mm
$Z_1 = 150$	$X_1 = 46$	$Y_1 = 34$
$Z_2 = 225$	$X_2 = 69$	$Y_2 = 52$

Working distance in mm	Horizontal values in mm	Vertical values in mm
$Z_3 = 375$	$X_3 = 116$	$Y_3 = 87$
$Z_4 = 1000$	$X_4 = 310$	$Y_4 = 232$

Distances in mm	2D min. code in mil	1D min. code in mil
80	2	2
150	3	2
190	4	3
225	5	3
375	8	5
500	10	7
1000	20	15

## DataMan 282 Readers with 8 mm Lens

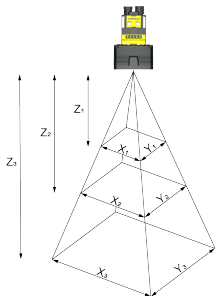

Working distance in mm	Horizontal values in mm	Vertical values in mm
$Z_1 = 300$	$X_1 = 223$	$Y_1 = 125$
$Z_2 = 750$	$X_2 = 526$	$Y_2 = 295$
$Z_3 = 1200$	$X_3 = 828$	$Y_3 = 466$

Working Distance in mm	2D min. code in mil	1D min. code in mil
300	12	7
750	18	12
1200	22	15

## DataMan 282 Readers with 12 mm Lens

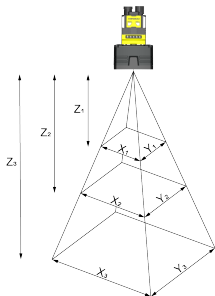

Working distance in mm	Horizontal values in mm	Vertical values in mm
$Z_1 = 300$	$X_1 = 141$	$Y_1 = 79$
$Z_2 = 750$	$X_2 = 343$	$Y_2 = 193$
$Z_3 = 1200$	$X_3 = 545$	$Y_3 = 306$

Working Distance in mm	2D min. code in mil	1D min. code in mil
300	10	6
750	18	11
1200	22	15

## DataMan 282 Readers with 16 mm Lens

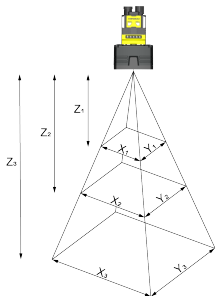

Working distance in mm	Horizontal values in mm	Vertical values in mm
$Z_1 = 300$	$X_1 = 105$	$Y_1 = 59$
$Z_2 = 750$	$X_2 = 256$	$Y_2 = 144$
$Z_3 = 1200$	$X_3 = 407$	$Y_3 = 229$

Working Distance in mm	2D min. code in mil	1D min. code in mil
300	8	5
750	16	9
1200	22	14



## Mounting the Reader

The reader provides mounting holes for attachment to a mounting surface.



**CAUTION:** The reader has to be grounded, either by mounting the reader to a fixture that is electrically grounded or by attaching a wire from the reader's mounting fixture to frame ground or Earth ground. If a ground wire is used, it has to be attached to one of the four mounting points on the bottom plate of the reader and not to the mounting points on the front of the reader.

The method of mounting depends on whether the reader is in straight or right-angle configuration, regardless of the product variant.

### Mounting the Reader in Straight Configuration

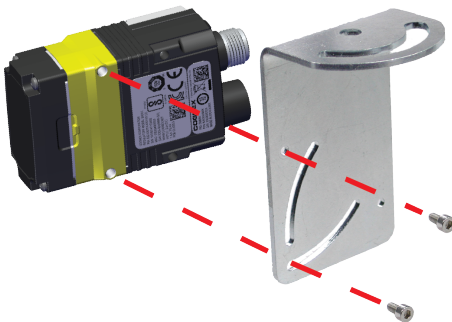

Align the holes on the mounting surface with the mounting holes on the reader. Insert the M3 screws into the mounting holes.

## Mounting the Reader in Right-Angle Configuration

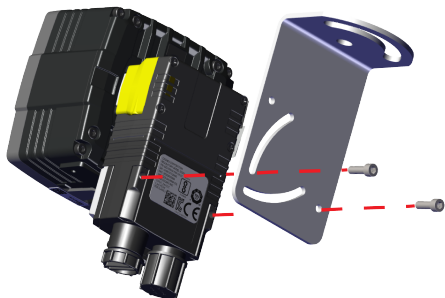

Align the holes on the mounting surface with the mounting holes on the reader. With the reader in right-angle position, only the back mounting holes can be used.

**Note:**

Mounting the reader at a slight angle ( $15^\circ$ ) reduces reflections and improves performance.

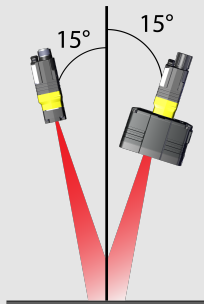

## Connecting the Ethernet Cable

**CAUTION:** The Ethernet cable shield has to be grounded at the far end. Whatever this cable is plugged into (typically a switch or router) should have a grounded Ethernet connector. A digital voltmeter has to be used to validate the grounding. If the far end device is not grounded, a ground wire should be added in compliance with local electrical codes.



1. Connect the Ethernet cable's M12 connector to the reader ENET connector.
2. Connect the Ethernet cable's RJ-45 connector to a switch/router or PC, as applicable.

### Note:



Besides powering the DataMan 280 readers through a Breakout Cable, it is possible to power DataMan through PoE connection as well, in which case it is not necessary to use a Breakout Cable. DataMan 282 readers do not support PoE.

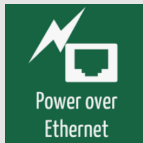

## DataMan 282 Readers LED Behavior with PoE

DataMan 282 Readers require 24 V DC to operate. If you try to power the reader with a PoE cable, the reader boots up, but the illumination shuts down. The error LED of the reader turns solid red to indicate an underpowered state. You can overwrite the behavior of the error LED in the **Inputs / Outputs** application step of the DataMan Setup Tool. For more information on how to configure the error LED, refer to the *DataMan Questions and Answers* document.

## Connecting the Power and I/O Breakout Cable

---



**CAUTION:** To reduce emissions, connect the far end of the Breakout cable shield to frame ground.

---

### Note:



- Perform wiring or adjustments to I/O devices when the reader is not receiving power.
  - You can clip unused wires short or use a tie made of non-conductive material to tie them back. Keep bare wires separated from the +24 V DC wire.
- 

1. Verify that the 24 V DC power supply is unplugged and not receiving power.
  2. Attach the +24 V DC connector of the Power and I/O Breakout cable and Ground wires to the corresponding terminals on the power supply. For more information, see *Specifications* on page 42.
- 



**CAUTION:** Never connect voltages other than 24 V DC. Always observe the polarity shown.

---

3. Attach the M12 connector of the Power and I/O Breakout Cable to the 24 V DC connector of the reader.
  4. Restore power to the 24 V DC power supply and turn it on if necessary.
- 

## Using your Device through USB

For a detailed description, see the DataMan 280 Reference Manual.

# Specifications

The following sections list general specifications for the reader.

## DataMan 280 Series Reader

Specification	DataMan 280	DataMan 282
Weight	6.2 mm: 141 g 16 mm: 169 g Right angle configuration adds 50 g	HPIT: 290 g Right angle configuration adds 50 g
Power	24 V DC +/- 10%, PoE (Power over Ethernet)	24 V DC $\pm$ 10%
24 V Supply	24 V DC $\pm$ 10% LPS or NEC class 2	24 V DC $\pm$ 10%
	Power consumption without USB device attached: <ul style="list-style-type: none"><li>• Average <math>\leq</math> 5 W using High-Powered Light</li><li>• Average <math>\leq</math> 6 W using High Frequency High-Powered Light</li><li>• Peak <math>\leq</math> 1.6 A using internal illumination</li></ul>	Power consumption: <ul style="list-style-type: none"><li>• Average 5 W</li><li>• Peak 10.7 W</li></ul>
Power over Ethernet Supply	PoE Class 3	N/A
Operating Temperature	0–40 °C (32–104 °F)	

Specification	DataMan 280	DataMan 282
Storage Temperature	-10–60 °C (14–140 °F)	
Humidity	<95% non-condensing	
Environmental	IP67  <b>Note:</b> IP67 rating applies only if all blind plugs and cables are attached properly, or the provided connector plug is installed. Also, make sure that the IP67-rated cover is installed properly.	
Shock	IEC 60068-2-27 - 500 shocks in each polarity of each (X, Y, and Z) axis, 3000 shocks total, semi-sinusoidal, 11 g, 10 ms	
Shock (Shipping and Storage)	ISTA-1A Standardized Testing - Packaged Products 150 lb or less	
Vibration	IEC 60068-2-6: vibration test in each of the three main axis for 2 hours @ 10 Gs (10 to 500 Hz at 100m/s <sup>2</sup> / 15 mm)	
Vibration (Shipping and Storage)	FedEx Vibration Testing for packaged products 150 lbs or less	
Codes	<b>1-D barcodes:</b> Codabar, Code 39, Code 128, Code 93, Code 25, Interleaved 2 of 5, Postal Codes, UPC/EAN/JAN, MSI <b>2-D barcodes:</b> Data Matrix (IDMax and IDQuick: ECC 0, 50, 80, 100, 140, and 200), QR Code, microQR, PDF 417, AztecCode, DotCode, MaxiCode	

## DataMan 280 Series Reader Image Sensor

Specification	DataMan 280	DataMan 282
Image Sensor	1/3-inch CMOS, global shutter	1/3-inch CMOS, global shutter
Image Sensor Properties	Diagonal size: 6.21 mm Pixel size: 3.45 $\mu\text{m}$ (H) x 3.45 $\mu\text{m}$ (V)	Diagonal size: 6.17 mm Pixel size: 2.8 $\mu\text{m}$ (H) x 2.8 $\mu\text{m}$ (V)
Image Resolution (pixels)	1440 x 1080 (1.6 mp)	1920 x 1080 pixels (2 mp)
Electronic Shutter Speed	Minimum exposure: 43 $\mu\text{s}$ Maximum exposure: 200 ms (with external illumination)	Minimum exposure: 30 $\mu\text{s}$ Maximum exposure: 200 ms (with external illumination)
Image Acquisition at Full Resolution	Maximum: 45 Hz	
Lens Type	6.2 mm (3 pos or LLM) with IR blocking filter, 16 mm (manual or LLM) with IR blocking filter, 6.2 mm UV, 6.2 mm and 16 mm IR, C-Mount acc.	8 mm, 12 mm, 16 mm High Speed Liquid Lens



## LED Wavelengths

The following table shows LED types and the related dominant wavelengths.

LED	$\lambda$ [nm]
RED	617
RED HPIL	617
BLUE	470
WHITE	6500K (Color temperature)
IR	850
IR HPIL	850
UV	365

# Regulations and Conformity

**i Note:** For the most current CE and UKCA declarations and regulatory conformity information, see the Cognex support site: [cognex.com/support](http://cognex.com/support).

DataMan 280 readers have Regulatory Model numbers 50208, 50210, 50215, 50216 and meet or exceed the requirements of all applicable standards organizations for safe operation. However, as with any electrical equipment, the best way to ensure safe operation is to operate them according to the agency guidelines that follow. Please read these guidelines carefully before using your device.

Safety and Regulatory	
Manufacturer	Cognex Corporation One Vision Drive Natick, MA 01760 USA
CE	DataMan 280 1.6 MP: Regulatory Model 50208 DataMan 280 2 MP L-shaped: Regulatory Model 50216 This is a class A product. In a domestic environment this product may cause radio interference in which case the user may be required to take immediate measures. This equipment complies with the essential requirements of the EU Directive 2014/30/EU. Declarations are available from your local representative.
EU RoHS	Compliant to the most recent applicable directive.
FCC	FCC Part 15, Class A This equipment has been tested and found to comply with the limits for a Class A digital device, pursuant to part 15 of the FCC Rules. These limits are designed to provide reasonable protection against harmful interference when the equipment is operated in a commercial environment. This equipment generates, uses, and can radiate radio frequency energy and, if not installed and used in accordance with the instruction manual, may cause harmful interference to radio communications. Operation of this equipment in a residential area is likely to cause harmful interference in which case the user will be required to correct the interference at his own expense.

### Safety and Regulatory

<p>Korea</p> 	<p>This device is certified for office use only and if used at home, there can be frequency interference problems.  <b>A급 기기 (업무용 방송통신기자재):</b> 이 기기는 업무용 (A급) 전자파적합기기로서 판매자 또는 사용자는 이 점을 주의하시기 바라며, 가정외의 지역에서 사용하는 것을 목적으로 합니다.          DataMan280 1.6 MP: R-R-CGX-50208          DataMan 280 1.6 MP L-shaped: R-R-CGX-50210          DataMan 280 2 MP: R-R-CGX-50215          DataMan 280 2 MP L-shaped: R-R-CGX-50216</p>
<p>TÜV</p>	<p>DataMan 280 1.6 MP: Regulatory Model 50208          DataMan 280 1.6 MP L-shaped: Regulatory Model 50210          DataMan 280 2 MP: Regulatory Model 50215          DataMan 280 2 MP L-shaped: Regulatory Model 50216</p> <p>NRTL: TÜV SÜD SCC/NRTL OSHA Scheme for UL/CAN 61010-1.</p> <p>CB report available upon request. TÜV SÜD, IEC/EN 61010-1.</p>
<p>UK</p>	<p>Regulatory Model 50208          Regulatory Model 50210          Regulatory Model 50215          Regulatory Model 50216          This is a class A product. In a domestic environment, this product can cause radio interference, in which case the user is required to take adequate measures. This equipment complies with the essential requirements of the Electromagnetic Compatibility Regulations 2016. Declarations are available from your local representative.</p>

# 中国大陆RoHS (Information for China RoHS Compliance)

根据中国大陆《电子信息产品污染控制管理办法》(也称为中国大陆RoHS), 以下部份列出了本产品中可能包含的有毒有害物质或元素的名称和含量。



	Hazardous Substances 有害物质					
Part Name 部件名称	Lead (Pb) 铅	Mercury (Hg) 汞	Cadmium (Cd) 镉	Hexavalent Chromium (Cr (VI)) 六价铬	Polybrominated biphenyls (PBB) 多溴联苯	Polybrominated diphenyl ethers (PBDE) 多溴二苯醚
Regulatory Model 50208 Regulatory Model 50210 Regulatory Model 50215 Regulatory Model 50216	X	O	O	O	O	O
<p>This table is prepared in accordance with the provisions of SJ/T 11364. 这个标签是根据SJ/T 11364 的规定准备的。</p> <p>O: Indicates that said hazardous substance contained in all of the homogeneous materials for this part is below the limit requirement of GB / T26572 - 2011. 表示本部件所有均质材料中含有的有害物质低于GB / T26572 - 2011 的限量要求。</p> <p>X: Indicates that said hazardous substance contained in at least one of the homogeneous materials used for this part is above the limit requirement of GB / T26572 - 2011. 表示用于本部件的至少一种均质材料中所含的危害物质超过GB / T26572 - 2011 的限制要求。</p>						

## For European Community Users

Cognex complies with Directive 2012/19/EU OF THE EUROPEAN PARLIAMENT AND OF THE COUNCIL of 4 July 2012 on waste electrical and electronic equipment (WEEE).

This product has required the extraction and use of natural resources for its production. It may contain hazardous substances that could impact health and the environment, if not properly disposed.

In order to avoid the dissemination of those substances in our environment and to diminish the pressure on the natural resources, we encourage you to use the appropriate take-back systems for product disposal. Those systems will reuse or recycle most of the materials of the product you are disposing in a sound way.



The crossed out wheeled bin symbol informs you that the product should not be disposed of along with municipal waste and invites you to use the appropriate separate take-back systems for product disposal.

If you need more information on the collection, reuse, and recycling systems, please contact your local or regional waste administration.

You may also contact your supplier for more information on the environmental performance of this product.

Copyright © 2023  
Cognex Corporation. All Rights Reserved.